

# How to Sew a Scarf Hat



Instruction by:

Ayeh Asiai  
Jon Fredley  
Patrick Johansson  
Orin Moyer

Are those cold days getting the best of you?  
Get your sewing gear ready because you're about to learn how to sew a  
scarf hat!

## Materials

- 62 by 14 inch scarf
- Sewing machine
- Matching thread
- Pins
- Iron
- Scissors
- Ruler

## Glossary

**Ride side:** The part of the hat scarf you would like to show on the outside

**Wrong side:** Reverse of right side

**Backstitching:** Sew two or three stitches, reverse machine stitching, stitch two or three stitches back, and then go forward again

**Basting stitches:** Long stitches made by hand or machine to hold down the fabric in place

**Zigzag:** A stitch that forms a “Z” pattern. Adjust settings on the machine for a zigzag stitch.

**Press:** To move the iron in an up and down motion on fabric for 3 seconds at a time to flatten fabric or make a crease

## Key to Diagrams

 Right side

 Wrong side

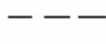
 Pencil & Baste stitching

 Stitch

 Back stitching

## Instructions

### Step 1

- Fold the scarf in half down the middle so that the right sides are together.

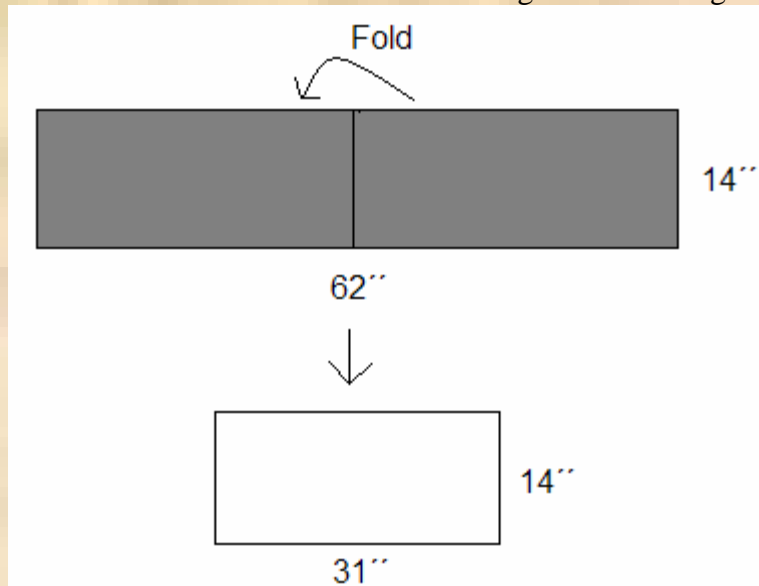

### Step 2

- Measure  $7\frac{1}{2}$  inches lengthwise from bottom corner folded edge. Insert pin at Point A.
- Measure  $7\frac{1}{2}$  inches widthwise from bottom corner folded edge. Insert pin at Point B.

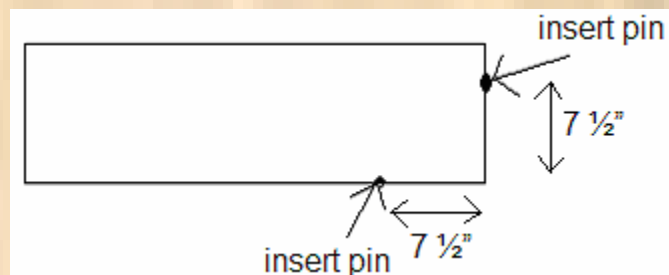

### Step 3

- Proceed by lightly drawing a gentle curve with a pencil from Pin A to Pin B.
- Follow the curve with baste stitching.
- Remove the pins.

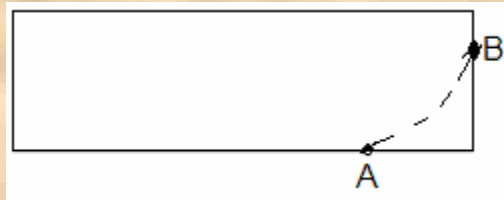

### Step 4

- Start with back stitching at Point A. (You've already removed the pins.)
- Stitch from Point A to Point B following the basting stitched line.
- Now back stitch at Point B.

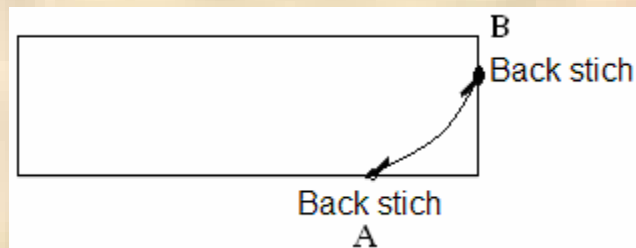

[au: should be "Backstitch"]

### Step 5

- Backstitch  $\frac{1}{4}$  inch from Point A—this will be called Point C.
- Stitch  $\frac{1}{4}$  inch from original stitching to  $\frac{1}{4}$  inch from Point B—this will be called Point D.
- Backstitch at Point D.

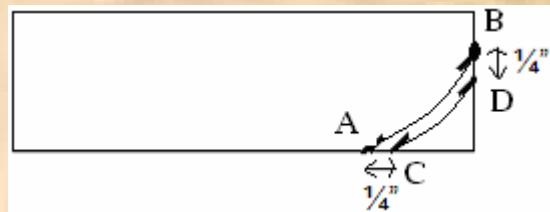

## Step 6

- Cut  $\frac{1}{4}$  inch away from the stitching from Point C to Point D.]
  - *Do not cut the stitches!*
- Continue cutting along C-D curve until the corner piece is completely cut off.



## Step 7

- Use the iron to press the seam until flat.

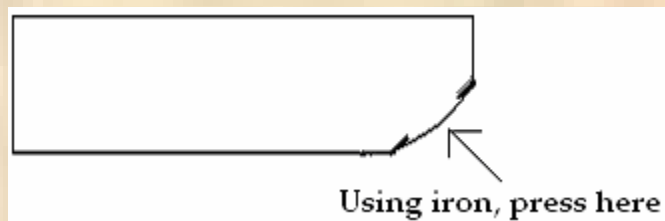

## Step 8

- Turn to the right side and press the seam.

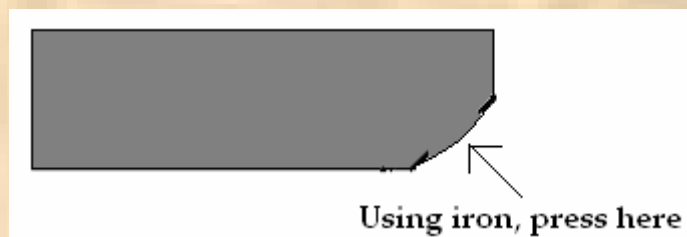

- You have now made yourself a beautiful scarf hat!

PENNSTATE



College of Agricultural Sciences  
Cooperative Extension



Prepared under the supervision of Jan Scholl, associate professor of agricultural and extension education.

Visit Penn State's College of Agricultural Sciences on the Web: [www.cas.psu.edu](http://www.cas.psu.edu)

Penn State College of Agricultural Sciences research, extension, and resident education programs are funded in part by Pennsylvania counties, the Commonwealth of Pennsylvania, and the U.S. Department of Agriculture.

Where trade names appear, no discrimination is intended, and no endorsement by Penn State Cooperative Extension is implied.

This publication is available in alternative media on request.

The Pennsylvania State University is committed to the policy that all persons shall have equal access to programs, facilities, admission, and employment without regard to personal characteristics not related to ability, performance, or qualifications as determined by University policy or by state or federal authorities. It is the policy of the University to maintain an academic and work environment free of discrimination, including harassment. The Pennsylvania State University prohibits discrimination and harassment against any person because of age, ancestry, color, disability or handicap, national origin, race, religious creed, sex, sexual orientation, or veteran status. Discrimination or harassment against faculty, staff, or students will not be tolerated at The Pennsylvania State University. Direct all inquiries regarding the nondiscrimination policy to the Affirmative Action Director, The Pennsylvania State University, 328 Boucke Building, University Park, PA 16802-5901, Tel 814-865-4700/V, 814-863-1150/TTY.

© The Pennsylvania State University 2005